

# AMIGA-1



**DREX0079**

## INSTALLATION INSTRUCTIONS

These installation instructions are for use with Drexan Energy Systems PipeGuard® Hot (PGH), PipeGuard Warm (PGW) and MultiTrace® (MT) self-regulating heater products. This kit may be installed in temperatures as low as -40°F (-40°C).

For technical support call Drexan at  
**1.800.663.6873**



HD190412-1 Rev 0

## Warnings

This is an electrical device and in order to ensure proper operation and prevent shock or fire it must be installed correctly. Read these important warnings. Follow all installation instructions.

**CAUTION:** Ground-fault equipment protection shall be provided to de-energize all normally ungrounded conductors of electrical heating cable sets, with ground fault settings sufficient to allow normal operation of the heater unless applicable codes permit otherwise, and to minimize the danger of fire from sustained electrical arcing if the heating cable is damaged or improperly installed and to comply with Drexan requirements, agency certifications and national electrical codes. Conventional circuit breakers may not stop arcing. Each heating device branch circuit or each heating device shall have ground fault equipment protection.

Metallic structures or materials such as metal pipes used to support the heater cable shall be grounded.

Component approvals and performance characteristics are based on Drexan specific parts only. Maximum surface temperature: +260°C (500°F)\*.

\*Applies to PGH product only

Substitution will void approvals and performance claims.

Component and heating cable ends must be kept dry before and during installation. Fire resistant thermal insulation should be used. Bond the metallic braid of the self-regulating heating cable to a suitable grounding (earth) terminal. De-energize before installation or servicing.



WARNING - EXPLOSION HAZARD - DO NOT DISCONNECT EQUIPMENT UNLESS POWER HAS BEEN SWITCHED OFF OR THE AREA IS KNOWN TO BE NON- HAZARDOUS.



AVERTISSEMENT - RISQUE D'EXPLOSION - AVANT DE DECONNECTER L'EQUIPEMENT, COUPER LE COURANT OU S'ASSURER QUE L'EMPLACEMENT EST DESIGNÉ NON DANGEREUX.

## Approvals



Class I, Div. 2, Groups A, B, C, D  
Class II, Div. 2, Groups F, G  
Class III

For use with Drexan HeatTracer PipeGuard Heating Cables only.

**CAUTION:** A ground fault protection device must be used with this heating device.

T-rating: Classified to rated output and conditions of use/limited pipe temperature.

## Cable-Specific Specifications

### PGH Only:

5-20 W/ft., Maximum 40A. 120-277V

Maximum intermittent exposure temperature  
446°F/230°C.

Min. bend radius: 1.72 in. (44 mm) @ -40°F/°C

### PGW/MT Only:

3-10 W/ft., Maximum 32A. 120-277V

Maximum continuous exposure temperature  
150°F/65°C.

Min. bend radius: 1.18 in. (30 mm) @ 68°F/20°C

# AMIGA-1 Kit Contents



Item	Qty	Description
1	1	Stanchion
2	1	Silicon Grommet
3	1	Cable Guide
4	1	Connector
5	1	Ground Assembly
6	1	Junction Box
7	1	Pipe Clamp
8	1	Core Sealer / 3/16" tube

6

Junction Box

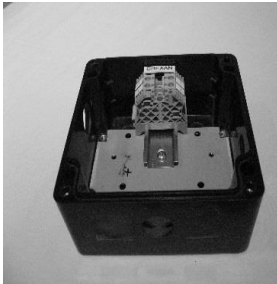

Pipe Clamp 7



Core Sealer

8



## Additional Materials Required

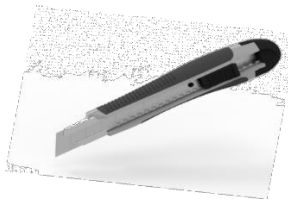

Knife

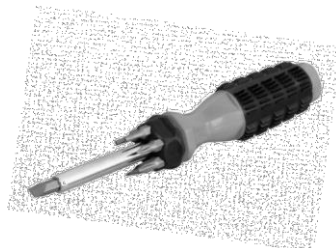

Multi Head Screwdriver



Glass FiberTape

# Installation OPTION # 1

For PGH, PGW and MT

Cut cable at 45° angle to pierce grommet.

1. Allow min. 15" (381 mm) for cable termination and min. 12" (305 mm) for the service loop.

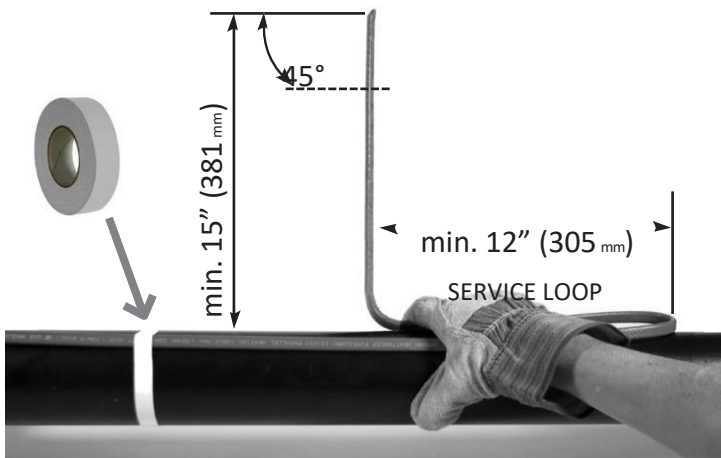

4. Attach stanchion with pipe clamps. **Do not tighten clamps onto cable.**

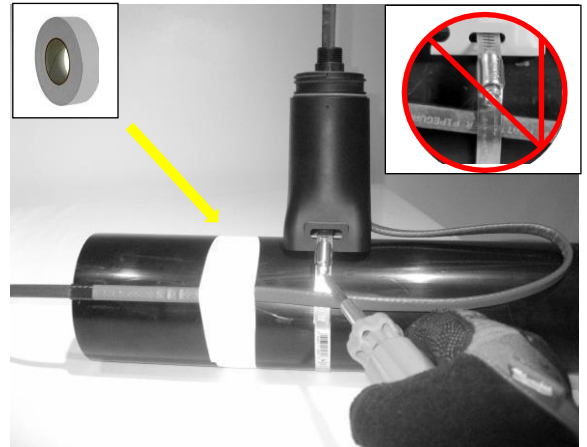

2. Ensure the shoulder of the connector is flush with stanchion.

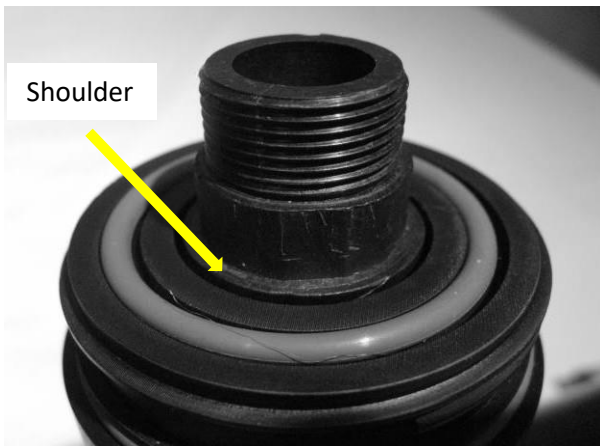

5. Ensure min. 9" (230 mm) remains for cable termination and tape service loop.

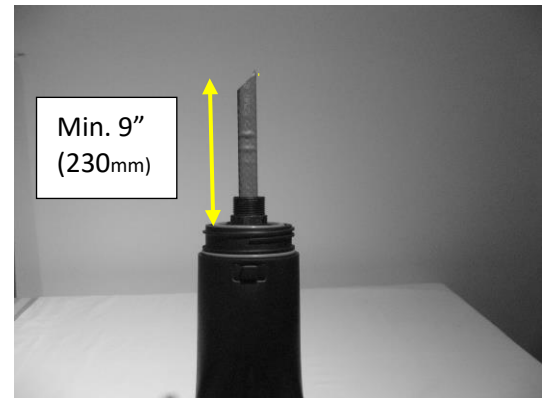

3. Feed cable(s) through the stanchion, piercing the grommet membrane.



6. Tighten the connector until it bottoms out.

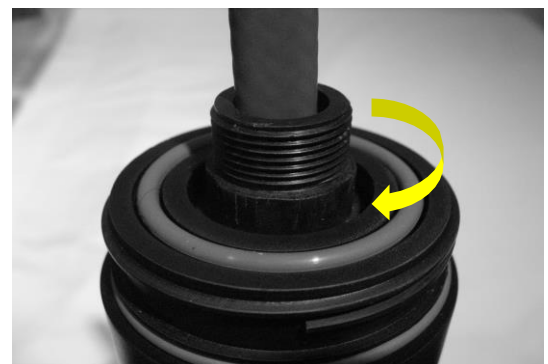

# Installation Instructions

**7.** Cut the outer jacket flush with the connector and remove.

✂ **Do not damage the ground braid.**

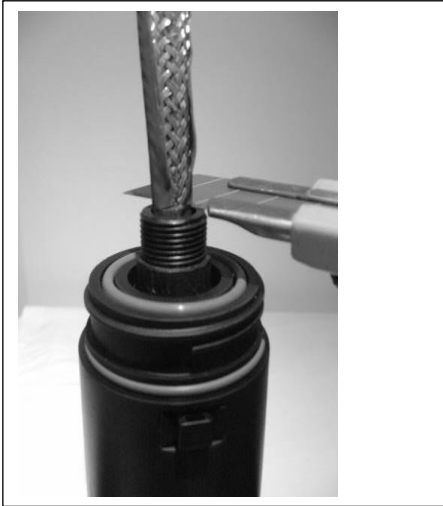

**8.** Wrap tape around the braid 1" (25 mm) from the end of the cut back outer jacket.



## **9A.** For PipeGuard Hot (PGH)

Cut the braid and inner jacket ½" (13 mm) from the outer edge of the tape.

Remove the braid, inner jacket, black fibers and spacer.

**9A.** ✂ Trim the braid back to the edge of the tape.  
✂ **Do not damage the inner jacket.**

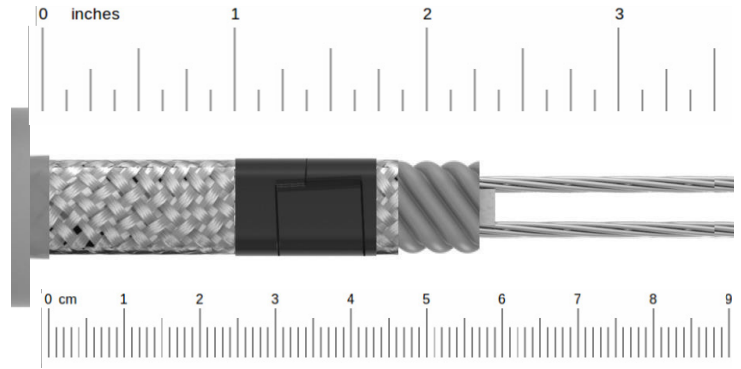

## **For PipeGuard Warm (PGW) or MultiTrace (MT) Cable**

### **9B**

Cut the braid ½" (13 mm) from the outer edge of the tape. Remove the braid.

Cut down the middle of the inner core between bus wires. This can be done with a scissors or knife. The core sealer will fit over the bus wires while still encapsulated by the heater core. It is not necessary to expose the bare bus wires.



✂ Trim the braid back to the edge of tape.  
✂ **Do not damage the inner core.**

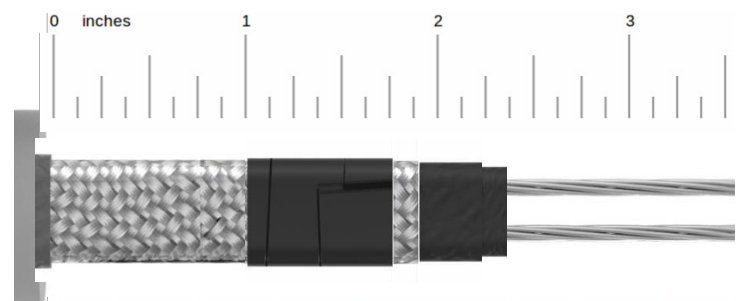

# Installation Instructions

- 10.** Slide junction box onto pipe stanchion. Ensure the o-ring between the stanchion and the junction box is in place.

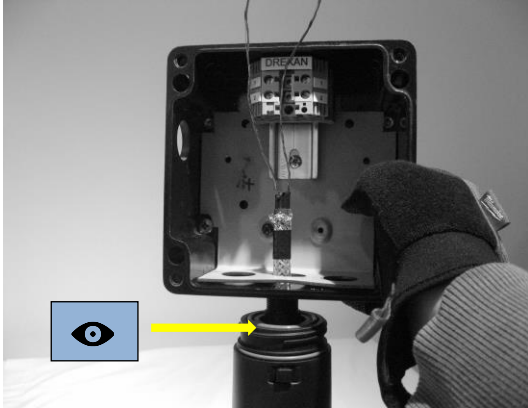

- 11.** Thread the ground nut onto connector and tighten.

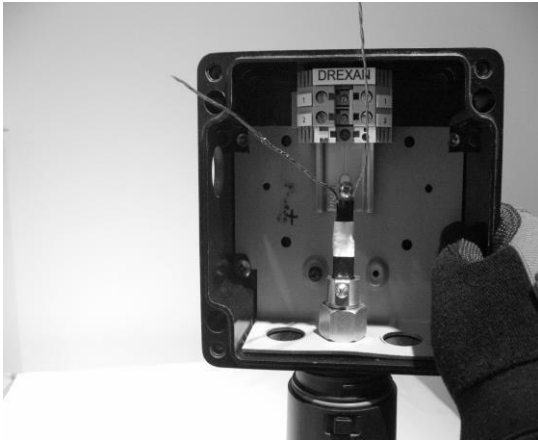

- 12.** Tighten screw to securely capture the ground braid.

 Ensure good ground contact.

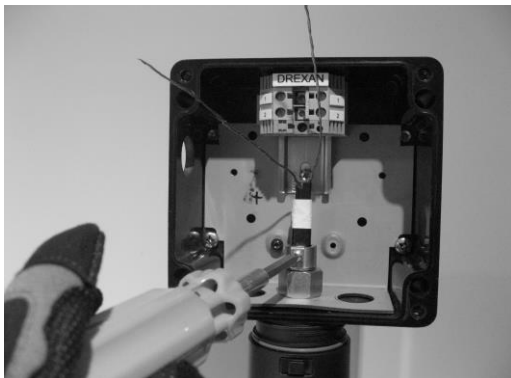

- 13.** Install Core Sealer over bus wires.



- 14.** Feed field wiring power and ground conductors into the cutout in junction box using suitable wiring method. For hazardous location installations the wiring method shall comply with one of the wiring methods permitted in the NEC or CEC (as applicable) for hazardous location classification of the installation. Ensure the grounding conductor and raceway used for field wiring are grounded on the grounding plate inside the junction box

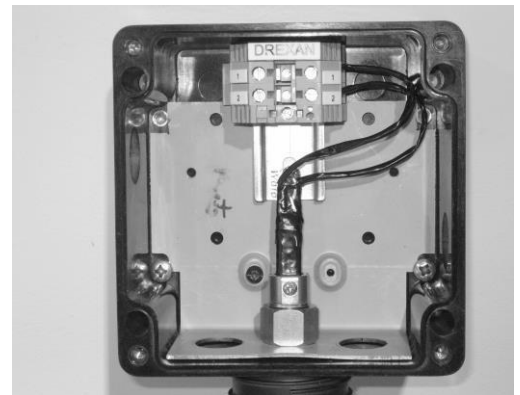

# Installation Instructions